

# FIXING, FASTENING AND SUPPORT PRODUCTS

## FEATURED PRODUCTS

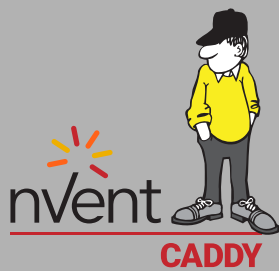

# Snap Close Conduit/Pipe Clamp

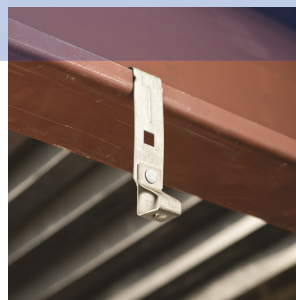
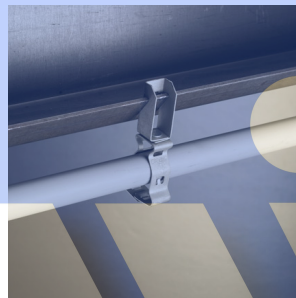
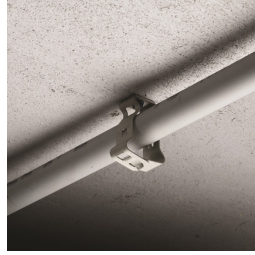

- May be used for either vertical or horizontal installations
- Eliminates need for offset bending conduit
- Finger closure, no tools required

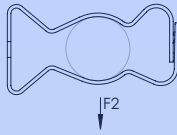
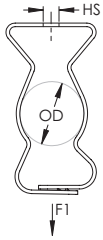

Material: Spring Steel  
Finish: nVent CADDY Armour



Part Number	Flexible Conduit Size	MC/AC Cable Size	EMT Conduit Size	Rigid Conduit/Pipe Size	Outer Diameter OD	Hole Size HS	Hole Type	Static Load 1 F1	Static Load 2 F2
6M4I	3/8"	14-2 to 12-3	-	-	0.551" - 0.709"	1/4"	Threaded	100 lb	25 lb
6M	3/8"	14-2 to 12-3	-	-	0.551" - 0.709"	9/32"	Plain	100 lb	25 lb
812M4I	-	-	1/2", 3/4"	1/2", 3/4"	0.709" - 1.181"	1/4"	Threaded	100 lb	25 lb
812M	-	-	1/2", 3/4"	1/2", 3/4"	0.709" - 1.181"	9/32"	Plain	100 lb	25 lb
16M4I	-	-	1"	1"	1.181" - 1.378"	1/4"	Threaded	100 lb	25 lb
16M	-	-	1"	1"	1.181" - 1.378"	9/32"	Plain	100 lb	25 lb
20M4I	-	-	1 1/4"	1 1/4"	1.378" - 1.654"	1/4"	Threaded	100 lb	25 lb
20M	-	-	1 1/4"	1 1/4"	1.378" - 1.654"	9/32"	Plain	100 lb	25 lb
24M4I	-	-	1 1/2"	1 1/2"	1.654" - 1.969"	1/4"	Threaded	100 lb	25 lb
24M	-	-	1 1/2"	1 1/2"	1.654" - 1.969"	9/32"	Plain	100 lb	25 lb
32M4I	-	-	2"	2"	1.969" - 2.362"	1/4"	Threaded	100 lb	25 lb
32M	-	-	2"	2"	1.969" - 2.362"	9/32"	Plain	100 lb	25 lb

# Bolt Close Conduit/Pipe Clamp



- Retained bolt and built-in nut means there are less parts to handle or drop
- Combo head bolt works with slotted, hex, #3 phillips or #2 robertson drivers

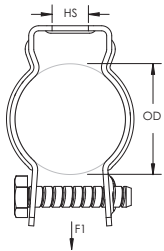

Part Number	Outer Diameter OD	EMT Conduit Size	Rigid Conduit/ Pipe Size	Hole Size HS	Static Load 1 F1	Static Load 2 F2	Certifications	Standard Packaging Quantity
Material: Steel – Finish: Electrogalvanized – Nut Type: Built-In Nut								
CD0B	0.670" – 0.840"	1/2"	1/2"	1/4"	200 lb	50 lb	cULus	100 pc
CD0B37	0.670" – 0.840"	1/2"	1/2"	3/8"	200 lb	50 lb	-	100 pc
CD1B	0.740" – 1.050"	3/4"	3/4"	1/4"	200 lb	50 lb	cULus, ITB	100 pc
CD1B37	0.740" – 1.050"	3/4"	3/4"	3/8"	200 lb	50 lb	-	100 pc
CD2B	1.000" – 1.315"	1"	1"	1/4"	200 lb	50 lb	cULus	100 pc
CD2B37	1.000" – 1.315"	1"	1"	3/8"	200 lb	50 lb	-	100 pc
CD2.5B	1.220" – 1.510"	1 1/4"	-	1/4"	200 lb	50 lb	cULus	100 pc
CD2.5B37	1.220" – 1.510"	1 1/4"	-	3/8"	200 lb	50 lb	-	100 pc
CD3B	1.410" – 1.740"	1 1/2"	1 1/4"	1/4"	200 lb	50 lb	cULus, ITB	100 pc
CD3B37	1.410" – 1.740"	1 1/2"	1 1/4"	3/8"	200 lb	50 lb	-	100 pc
CD4B	1.750" – 1.900"	-	1 1/2"	5/16"	200 lb	50 lb	cULus, ITB	50 pc
CD4B37	1.750" – 1.900"	-	1 1/2"	3/8"	200 lb	50 lb	-	50 pc
CD5B	1.910" – 2.875"	2"	2"	5/16"	200 lb	50 lb	cULus, ITB	50 pc
CD5B37	1.910" – 2.875"	2"	2"	3/8"	200 lb	50 lb	-	50 pc
Material: Steel – Finish: Electrogalvanized – Nut Type: Hex Nut								
CD6B	2.600" – 3.000"	2 1/2"	2 1/2"	5/16"	350 lb	50 lb	-	25 pc
CD7B	3.150" – 3.500"	3"	3"	5/16"	350 lb	50 lb	-	25 pc
CD8B	3.740" – 4.130"	3 1/2"	3 1/2"	5/16"	350 lb	50 lb	-	10 pc
CD9B	4.250" – 4.530"	4"	4"	5/16"	350 lb	50 lb	-	10 pc

Part Number	Outer Diameter OD	EMT Conduit Size	Rigid Conduit/ Pipe Size	Hole Size HS	Static Load 1 F1	Static Load 2 F2	Certifications	Standard Packaging Quantity
Material: Stainless Steel 304 [EN 1.4301] - Nut Type: Hex Nut								
CD0BSS	0.670" - 0.840"	1/2"	1/2"	1/4"	200 lb	50 lb	cULus	100 pc
CD1BSS	0.740" - 1.050"	3/4"	3/4"	1/4"	200 lb	50 lb	cULus	100 pc
CD2BSS	1.000" - 1.315"	1"	1"	1/4"	200 lb	50 lb	-	100 pc
CD2.5BSS	1.220" - 1.510"	1 1/4"	-	1/4"	200 lb	50 lb	cULus	100 pc
CD3BSS	1.410" - 1.740"	1 1/2"	1 1/4"	1/4"	200 lb	50 lb	cULus	100 pc
CD4BSS	1.750" - 1.900"	-	1 1/2"	5/16"	200 lb	50 lb	cULus	50 pc
CD5BSS	1.910" - 2.875"	2"	2"	5/16"	350 lb	50 lb	cULus	50 pc
CD6BSS	2.600" - 3.000"	2 1/2"	2 1/2"	5/16"	350 lb	50 lb	-	25 pc
CD7BSS	3.150" - 3.500"	3"	3"	5/16"	350 lb	50 lb	-	25 pc
CD8BSS	3.740" - 4.130"	3 1/2"	3 1/2"	5/16"	350 lb	50 lb	-	10 pc
CD9BSS	4.250" - 4.530"	4"	4"	5/16"	350 lb	50 lb	-	10 pc



# EM-M Conduit/Pipe to Flange Clip



- Supports conduit/pipe or cable from beam flanges
- Snap close clip pivots a full 360°
- Requires only a hammer to install

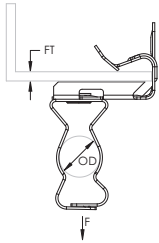

Material: Spring Steel  
Finish: nVent CADDY Armour



Part Number	EMT Conduit Size	Rigid Conduit/Pipe Size	MC/AC Cable Size	Outer Diameter OD	Flange Thickness FT	Flexible Conduit Size	Static Load F	Certifications
812M1318	1/2", 3/4"	1/2", 3/4"	-	0.709" - 1.181"	13/16" - 1 1/8"	-	75 lb	cULus
812M24	1/2", 3/4"	1/2", 3/4"	-	0.710" - 1.180"	1/8" - 1/4"	-	75 lb	-
812M58	1/2", 3/4"	1/2", 3/4"	-	0.710" - 1.180"	5/16" - 1/2"	-	75 lb	-
812M912	1/2", 3/4"	1/2", 3/4"	-	0.710" - 1.180"	9/16" - 3/4"	-	75 lb	-
16M24	1"	1"	-	1.180" - 1.380"	1/8" - 1/4"	-	75 lb	-
16M58	1"	1"	-	1.180" - 1.380"	5/16" - 1/2"	-	75 lb	-
16M912	1"	1"	-	1.180" - 1.380"	9/16" - 3/4"	-	75 lb	-
20M24	1 1/4"	1 1/4"	-	1.380" - 1.650"	1/8" - 1/4"	-	75 lb	-
20M58	1 1/4"	1 1/4"	-	1.380" - 1.650"	5/16" - 1/2"	-	75 lb	-
20M912	1 1/4"	1 1/4"	-	1.380" - 1.650"	9/16" - 3/4"	-	75 lb	-
24M24	1 1/2"	1 1/2"	-	1.650" - 1.970"	1/8" - 1/4"	-	75 lb	-
24M58	1 1/2"	1 1/2"	-	1.650" - 1.970"	5/16" - 1/2"	-	75 lb	-
24M912	1 1/2"	1 1/2"	-	1.650" - 1.970"	9/16" - 3/4"	-	75 lb	cULus
32M24	2"	2"	-	1.970" - 2.360"	1/8" - 1/4"	-	75 lb	-
32M58	2"	2"	-	1.970" - 2.360"	5/16" - 1/2"	-	75 lb	-
32M912	2"	2"	-	1.970" - 2.360"	9/16" - 3/4"	-	75 lb	-
6M24	-	3/8"	14-2 to 12-3	0.550" - 0.710"	1/8" - 1/4"	3/8"	75 lb	-
6M58	-	3/8"	14-2 to 12-3	0.550" - 0.710"	5/16" - 1/2"	3/8"	75 lb	-
6M912	-	3/8"	14-2 to 12-3	0.550" - 0.710"	9/16" - 3/4"	3/8"	75 lb	-

# 123-M Conduit to Z Purlin Clip



- Snap-close conduit support
- Conduit clip rotates 360 degrees
- Supports conduit from purlin

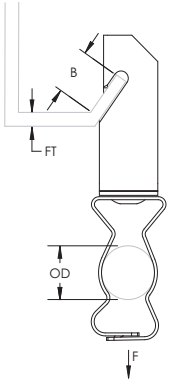

Material: Spring Steel  
 Finish: nVent CADDY Armour



Part Number	Flexible Conduit Size	MC/AC Cable Size	EMT Conduit Size	Outer Diameter OD	Flange Thickness FT	B	Static Load F
1236M	3/8"	14-2 to 12-3	-	0.551" - 0.709"	0.06" - 0.10"	5/8" Min	100 lb
123812M	-	-	1/2", 3/4"	0.709" - 1.181"	0.06" - 0.10"	5/8" Min	100 lb
12316M	-	-	1"	1.181" - 1.378"	0.06" - 0.10"	5/8" Min	100 lb
12320M	-	-	1 1/4"	1.378" - 1.654"	0.06" - 0.10"	5/8" Min	100 lb

# BC200-CD Conduit to Beam Clamp



- Eliminates offset bending conduit
- Threaded hole on back
- Ideal for electrical, mechanical, and HVAC applications

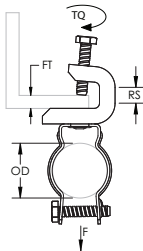

Material: Steel  
Finish: Electrogalvanized



Part Number	Outer Diameter OD	EMT Conduit Size	Rigid Conduit Size	Flange Thickness FT	Rod Size RS	Torque TQ	Static Load F	Certifications
BC200CD0B	0.670" – 0.840"	1/2"	1/2"	1/2" Max	1/4"	3 ft lb	100 lb	cULus
BC200CD1B	0.740" – 1.050"	3/4"	3/4"	1/2" Max	1/4"	3 ft lb	100 lb	cULus, ITB
BC200CD2B	1.000" – 1.315"	1"	1"	1/2" Max	1/4"	3 ft lb	100 lb	cULus
BC200CD2.5B	1.220" – 1.510"	1 1/4"	-	1/2" Max	1/4"	3 ft lb	100 lb	cULus
BC200CD3B	1.410" – 1.740"	1 1/2"	1 1/4"	1/2" Max	1/4"	3 ft lb	100 lb	cULus
BC200CD4B	1.750" – 1.900"	-	1 1/2"	1/2" Max	1/4"	3 ft lb	100 lb	cULus
BC200CD5B	1.910" – 2.875"	2"	2"	1/2" Max	1/4"	3 ft lb	100 lb	cULus



# Snap Close Conduit/Pipe Clamp with Shot-Fire Bracket

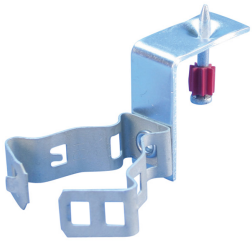

- Eliminates need for offset bending conduit
- Finger closure, no tools required
- Complete with shot-fire bracket and pre-assembled drive pin from Powers Fasteners, Inc.
- Quickly and easily attaches to concrete, steel or composite metal decking
- Integrated pin installs easily using powder-actuated or single-shot gas-actuated tools
- ICC-ES ESR-2024 evaluation report available for drive pin from Powers Fasteners, Inc

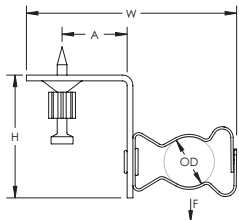

Material: Steel, Spring Steel  
 Finish: Electrogalvanized, nVent CADDY Armour

Part Number	Flexible Conduit Size	MC/AC Cable Size	EMT Conduit Size	Rigid Conduit/Pipe Size	Outer Diameter OD	Height H	Width W	A	Static Load F
6MSF	3/8"	14-2 to 12-3	-	-	0.55" - 0.70"	1 11/16"	3 1/8"	1.3"	25 lb
812MSF	-	-	1/2", 3/4"	1/2", 3/4"	0.70" - 1.18"	2"	3 3/8"	1.3"	25 lb
16MSF	-	-	1"	1"	1.18" - 1.38"	1 3/4"	4"	1.3"	25 lb

Uses Powers Fasteners, Inc. part number 50032.

Static load was established based on a 1" (25.4 mm) embedment depth and 3,000 psi (20.68 MPa) lightweight concrete. For variations in embedment and material please consult [www.powers.com](http://www.powers.com).

Pre-assembled drive pin from Powers Fasteners, Inc. works with Powers® C4CZ, Simpson® GCN-MEPKT, SPIT® P1000, P200, P2201, P3500 / PA3500, P35s, P45, P60, P7201, Sniper; Ramset® 721, Cobra, D45 / D60 / D60L, M70, SA270, T3SS, TS750P, TS60P, Viper; Hilti® DX35, DX350 / DX351 / DX36M, DX100 / DX200, DX460, DXA40, DXA41, DXE72 / DX400; Würth Diva-1, BST-1, BST-2 or equivalent nailers.



# Bolt Close Conduit/Pipe Clamp with Shot-Fire Bracket

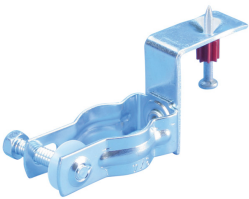

- Retained bolt and built-in nut means there are less parts to handle or drop
- Combo head bolt works with slotted, hex, #3 phillips or #2 robertson drivers
- Complete with shot-fire bracket and pre-assembled drive pin from Powers Fasteners, Inc.
- Quickly and easily attaches to concrete, steel or composite metal decking
- Integrated pin installs easily using powder-actuated or single-shot gas-actuated tools
- ICC-ES ESR-2024 evaluation report available for drive pin from Powers Fasteners, Inc

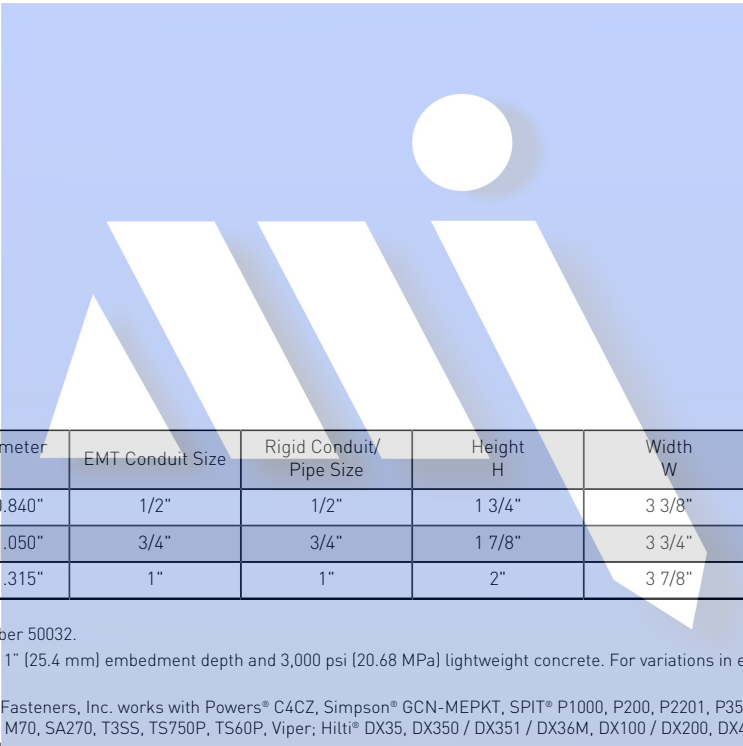
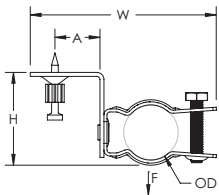

Material: Steel  
 Finish: Electrogalvanized

Part Number	Outer Diameter OD	EMT Conduit Size	Rigid Conduit/ Pipe Size	Height H	Width W	A	Static Load F
CD0BSF	0.670" – 0.840"	1/2"	1/2"	1 3/4"	3 3/8"	1.3"	100 lb
CD1BSF	0.740" – 1.050"	3/4"	3/4"	1 7/8"	3 3/4"	1.3"	100 lb
CD2BSF	1.000" – 1.315"	1"	1"	2"	3 7/8"	1.3"	100 lb

Uses Powers Fasteners, Inc. part number 50032.

Static load was established based on a 1" (25.4 mm) embedment depth and 3,000 psi (20.68 MPa) lightweight concrete. For variations in embedment and material please consult [www.powers.com](http://www.powers.com).

Pre-assembled drive pin from Powers Fasteners, Inc. works with Powers® C4CZ, Simpson® GCN-MEPKT, SPIT® P1000, P200, P2201, P3500 / PA3500, P35s, P45, P60, P7201, Sniper; Ramset® 721, Cobra, D45 / D60 / D60L, M70, SA270, T3SS, TS750P, TS60P, Viper; Hilti® DX35, DX350 / DX351 / DX36M, DX100 / DX200, DX460, DXA40, DXA41, DXE72 / DX400; Würth Diva-1, BST-1, BST-2 or equivalent nailers.

# Cable/Conduit Clip

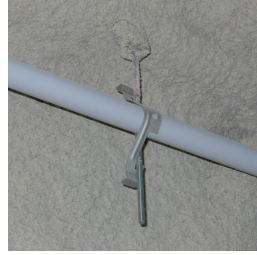

- Supports conduit to rod, wire or flange
- Can also be used for flexible metallic tubing, armored cable, portable cables, control tubes and communications cable
- Available for EMT, rigid, ENT, IMT, MC/AC and aluminum conduit
- No installation tools required

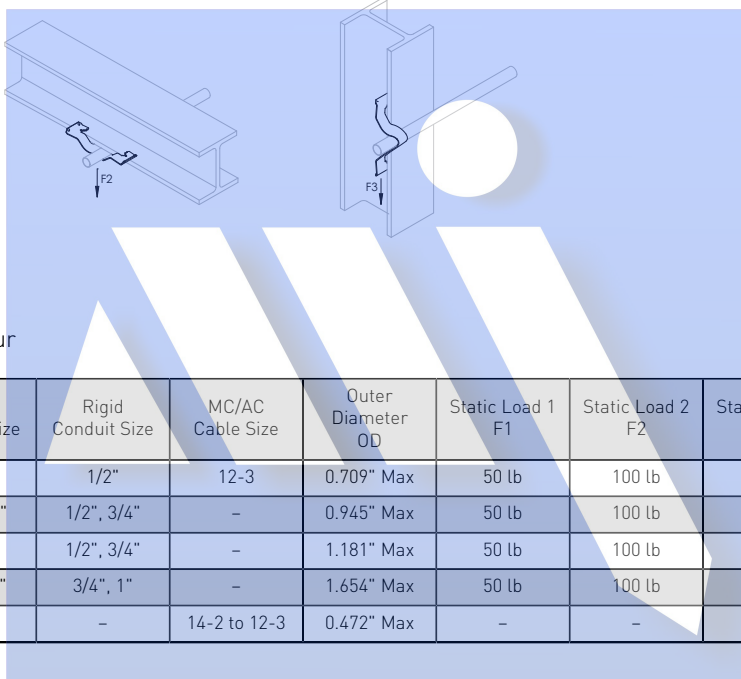
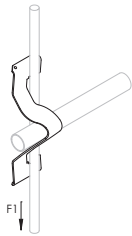

Material: Spring Steel  
Finish: nVent CADDY Armour



Part Number	EMT Conduit Size	Rigid Conduit Size	MC/AC Cable Size	Outer Diameter OD	Static Load 1 F1	Static Load 2 F2	Static Load 3 F3	Certifications	Standard Packaging Quantity
K8	1/2"	1/2"	12-3	0.709" Max	50 lb	100 lb	15 lb	cULus	100 pc
K12	1/2", 3/4"	1/2", 3/4"	-	0.945" Max	50 lb	100 lb	15 lb	cULus, ITB	100 pc
K16	3/4", 1"	1/2", 3/4"	-	1.181" Max	50 lb	100 lb	15 lb	cULus, ITB	100 pc
K20	1", 1 1/4"	3/4", 1"	-	1.654" Max	50 lb	100 lb	22 lb	cULus, ITB	100 pc
KX	-	-	14-2 to 12-3	0.472" Max	-	-	-	cULus	100 pc

Conduit Size	#10 or #12 Wire	#8 or #9 Wire	3/16" or 1/4" Rod	1/8" - 1/4" Flange	5/16" - 3/8" Flange	7/16" - 1/2" Flange
1/2" EMT	K8	K8	K8	K8	K12	K12
1/2" Rigid	K8	K12	K12	K12	K12	K16
3/4" EMT	K12	K12	K12	K12	K16	K16
3/4" Rigid	K12	K12	K16	K16	K20	K20
1" EMT	-	K16	K16	K16	K20	K20
1" Rigid	-	-	-	K20	K20	K20
1 1/4" EMT	-	K20	K20	K20	-	-

Cable Size	#12 Wire	#8, #9, #10 Wire
14-2 (.433" - .475" OD)	KX	KX
14-3 (.453" - .500" OD)	KX	KX
12-2 (.467" - .510" OD)	KX	KX
12-3 (.489" - .535" OD)	KX	K8

May require dedicated drop wire/rod and EC311. Consult local authority.  
 For horizontal application only when installing conduit.



# Snap Close Conduit to Rod/Wire Clip



- Provides attachment of conduit and boxes

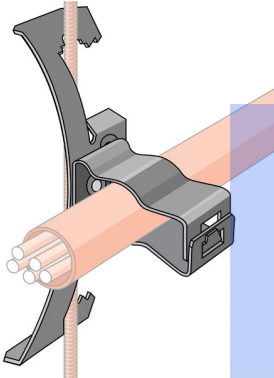

Material: Spring Steel  
Finish: nVent CADDY Armour



Part Number	EMT Conduit Size	MC/AC Cable Size	Outer Diameter	Flexible Conduit Size	Rod Size	Wire Size	Flange Thickness	Certifications
4Z34812M	1/2", 3/4"	-	0.71" - 1.18"	-	1/4"	#12	1/8" - 3/8"	cULus
6Z34812M	1/2", 3/4"	-	0.71" - 1.18"	-	3/8"	-	3/8" - 7/16"	cULus
8Z34812M	1/2", 3/4"	-	0.71" - 1.18"	-	1/2", 5/8"	-	-	cULus
4Z3416M	1"	-	1.18" - 1.38"	-	1/4"	#12	1/8" - 3/8"	cULus
6Z3416M	1"	-	1.18" - 1.38"	-	3/8"	-	3/8" - 7/16"	cULus
4Z346M	-	14-2 to 12-3	0.55" - 0.71"	3/8"	1/4"	#12	1/8" - 3/8"	-
6Z346M	-	14-2 to 12-3	0.55" - 0.71"	3/8"	3/8"	-	3/8" - 7/16"	-

1/2" and 5/8" rod sizes are to be installed on threaded rod only.  
NEC® 300.11 requires dedicated drop wire/rod and EC311.

# H-Ti/T Rod to Flange Clip



- Suspends threaded rod from beam flanges
- Threaded rod hanger can swivel to provide a vertical dropdown
- Requires only a hammer to install

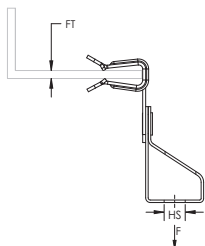

Material: Spring Steel  
Finish: nVent CADDY Armour



Part Number	Hole Size HS	Hole Type	Flange Thickness FT	Static Load F	Standard Packaging Quantity
4TI24	1/4"	Threaded	1/8" - 1/4"	200 lb	100 pc
4TI58	1/4"	Threaded	5/16" - 1/2"	200 lb	100 pc
4TI912	1/4"	Threaded	9/16" - 3/4"	200 lb	100 pc
6TA24	3/8"	Plain	1/8" - 1/4"	200 lb	100 pc
6TA58	3/8"	Plain	5/16" - 1/2"	200 lb	100 pc
6TA912	3/8"	Plain	9/16" - 3/4"	200 lb	100 pc
6TI24	3/8"	Threaded	1/8" - 1/4"	200 lb	100 pc
6TI58	3/8"	Threaded	5/16" - 1/2"	200 lb	100 pc
6TI912	3/8"	Threaded	9/16" - 3/4"	200 lb	100 pc

# VF-Ti/T Rod to C-Purlin Clip



- Hammer-on or install from the floor with the VAFT tool
- Provides an attachment for nVent CADDY Speed Link assemblies, wire, S-hooks, or chain from purlin and bar joist

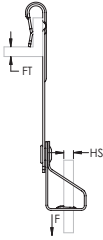

Material: Spring Steel  
Finish: nVent CADDY Armour



Part Number	Hole Size HS	Hole Type	Flange Thickness FT	Height H	Static Load F
VF144TI	1/4"	Threaded	1/16" - 1/4"	5 3/16"	160 lb
VF146T	3/8"	Plain	1/16" - 1/4"	5 3/16"	160 lb
VF146TI	3/8"	Threaded	1/16" - 1/4"	5 3/16"	160 lb

# AF-Ti/T Rod to Z Purlin Clip



- Used to support 1/4" and 3/8" threaded rod from purlin beam flanges 1/16" thru 1/4" thick
- Hammer-on or install from the floor with the VAFT tool
- Provides method for attaching rod to Z purlin

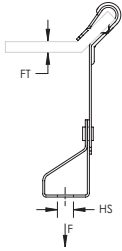

Material: Spring Steel  
Finish: nVent CADDY Armour



Part Number	Hole Size HS	Hole Type	Flange Thickness FT	Static Load F
AF144TI	1/4"	Threaded	1/16" - 1/4"	100 lb
AF146T	3/8"	Plain	1/16" - 1/4"	100 lb
AF146TI	3/8"	Threaded	1/16" - 1/4"	100 lb



# BC Beam Clamp

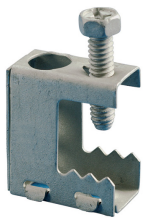

- Easy installation to beam flanges

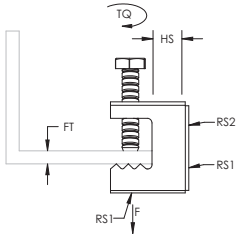

Material: Spring Steel  
 Finish: nVent CADDY Armour



Part Number	Rod Size 1 RS1	Rod Size 2 RS2	Hole Size HS	Flange Thickness FT	Torque TQ	Static Load F
BC	1/4"	#10	7/16"	1/2" Max	20 in lb	100 lb

Setscrew must be tightened and torqued onto the sloped side of the I-beam.



# Drop-In Anchor



- Internal thread provides easy removal and serviceability
- Installs flush or below the base surface

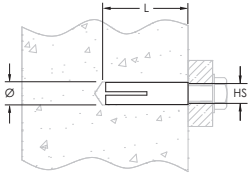

Material: Steel  
Finish: Electrogalvanized

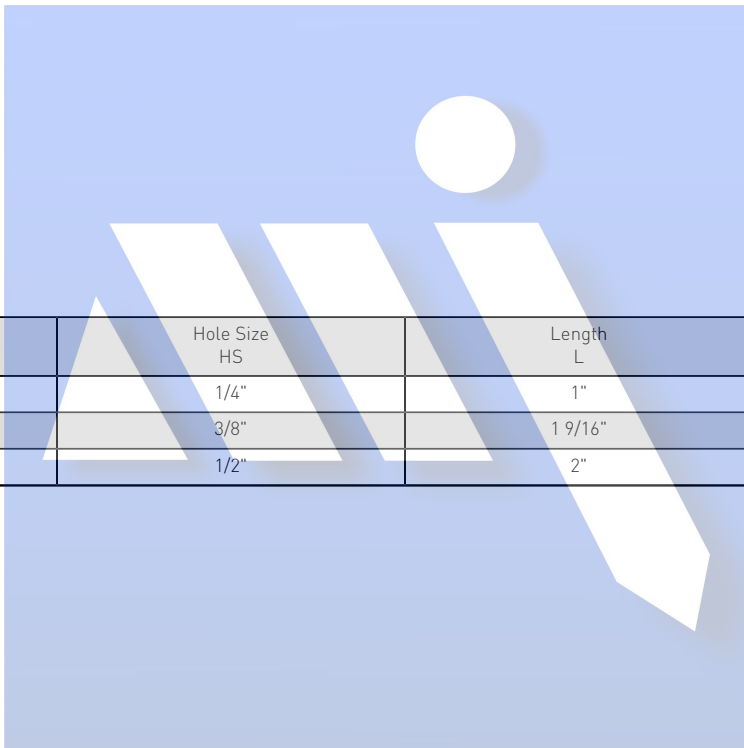

Part Number	Hole Size HS	Length L	Diameter Ø
CA0025EG	1/4"	1"	3/8"
CA0037EG	3/8"	1 9/16"	1/2"
CA0050EG	1/2"	2"	5/8"

# Thread Install Rod Hanger with Shot-Fire Bracket

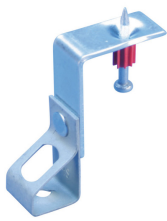

- Suspends threaded rod without the need for additional hardware
- Complete with shot-fire bracket and pre-assembled drive pin from Powers Fasteners, Inc.
- Quickly and easily attaches to concrete, steel or composite metal decking
- Integrated pin installs easily using powder-actuated or single-shot gas-actuated tools
- ICC-ES ESR-2024 evaluation report available for drive pin from Powers Fasteners, Inc

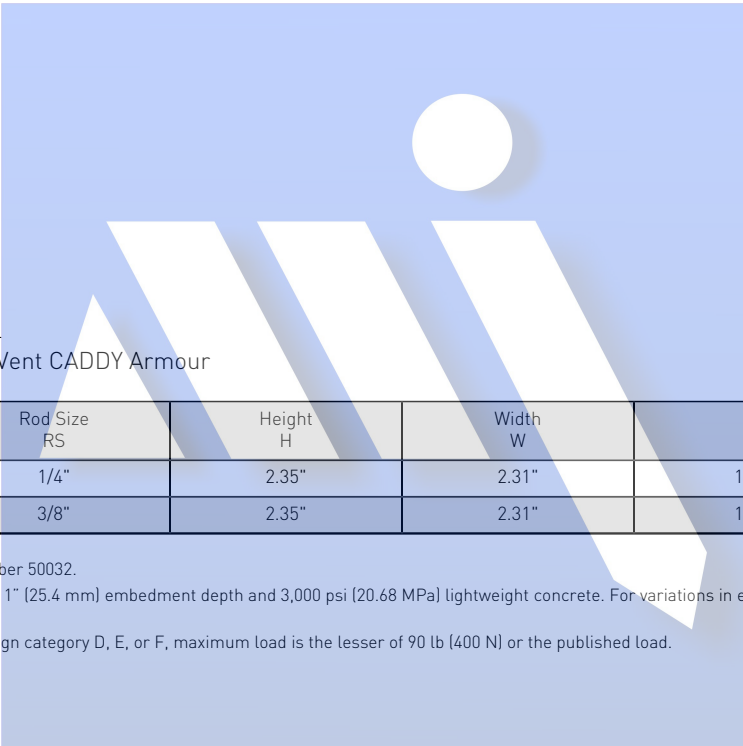
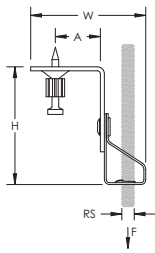

Material: Steel, Spring Steel  
 Finish: Electrogalvanized, nVent CADDY Armour

Part Number	Rod Size RS	Height H	Width W	A	Static Load F
4TIBSF	1/4"	2.35"	2.31"	1.3"	100 lb
6TIBSF	3/8"	2.35"	2.31"	1.3"	100 lb

Uses Powers Fasteners, Inc. part number 50032.

Static load was established based on a 1" (25.4 mm) embedment depth and 3,000 psi (20.68 MPa) lightweight concrete. For variations in embedment and material please consult [www.powers.com](http://www.powers.com).

For shot-fired supports in seismic design category D, E, or F, maximum load is the lesser of 90 lb (400 N) or the published load.

# Threaded Rod

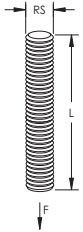
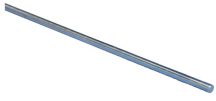

Material: Steel  
 Tensile Strength: 58,000 psi  
 Yield Strength: 36,000 psi

Part Number	Rod Size RS	Length L	Static Load F
Finish: Plain			
0503706PL	3/8"	6'	600 lb
0503710PL	3/8"	10'	610 lb
0503712PL	3/8"	12'	600 lb
Finish: Electrogalvanized			
0502506EG	1/4"	6'	240 lb
0502510EG	1/4"	10'	240 lb
0503706EG	3/8"	6'	600 lb
0503710EG	3/8"	10'	610 lb
0503712EG	3/8"	12'	600 lb
0505006EG	1/2"	6'	1,130 lb
0505010EG	1/2"	10'	1,130 lb
0505012EG	1/2"	12'	1,130 lb
0506206EG	5/8"	6'	1,810 lb
0506210EG	5/8"	10'	1,810 lb
0506212EG	5/8"	12'	1,810 lb
0507510EG	3/4"	10'	2,710 lb
0507512EG	3/4"	12'	2,710 lb
0508706EG	7/8"	6'	3,770 lb
0508710EG	7/8"	10'	3,770 lb

Load based on Max. 650 degrees F.

# Drop Smooth Rod with Shot-Fire Bracket

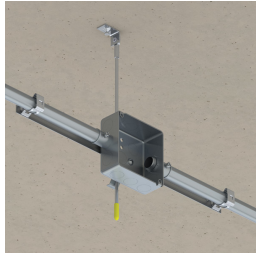

- Quickly and easily attaches to concrete, steel or composite metal decking
- Integrated pin installs easily using powder-actuated or single-shot gas-actuated tools
- Works with most standard nVent CADDY spring steel fasteners designed for rod attachments
- Rod is rigid and does not require secondary attachment to ceiling grid per NEC 300.11
- Stocked inventory - available when you need it
- Includes pre-assembled end-cap
- Specialized packaging simplifies material handling and minimizes sorting
- Rods are ready to install out of the box

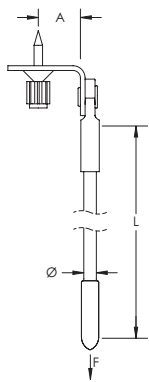

Material: Steel  
Finish: Electrogalvanized



Part Number	Length L	Diameter Ø	A	Static Load F
DR4SF12	12"	0.215"	1.3"	95 lb
DR4SF24	24"	0.215"	1.3"	95 lb
DR4SF36	36"	0.215"	1.3"	95 lb
DR4SF40	40"	0.215"	1.3"	95 lb
DR4SF48	48"	0.215"	1.3"	95 lb

Uses Powers Fasteners, Inc. part number 50378.  
 Static load was established based on a 1-1/8" (28.6 mm) embedment depth and 3,000 psi (20.68 Mpa) normal-weight concrete. For variations in embedment and material please consult [www.powers.com](http://www.powers.com).  
 Pre-assembled drive pin from Powers Fasteners, Inc. works with Powers® C4CZ, Simpson® GCN-MEPKT, SPIT® P1000, P200, P2201, P3500 / PA3500, P35s, P45, P60, P7201, Sniper; Ramset® 721, Cobra, D45 / D60 / D60L, M70, SA270, T3SS, TS750P, TS60P, Viper; Hilti® DX35, DX350 / DX351 / DX36M, DX100 / DX200, DX460, DXA40, DXA41, DXE72 / DX400; Würth Diva-1, BST-1, BST-2 or equivalent nailers.  
 For shot-fired supports in seismic design category D, E, or F, maximum load is the lesser of 90 lb (400 N) or the published load.  
 Exempt from seismic design when supporting conduits less than 2-1/2" (64 mm) trade size, regardless of Ip.

# Drop Threaded Rod with Shot-Fire Bracket

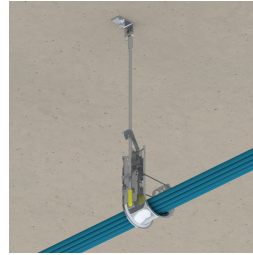
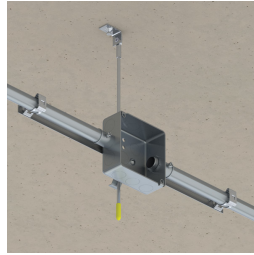
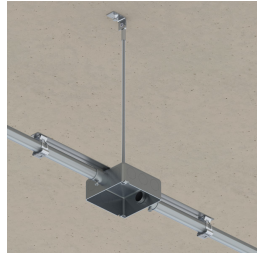

- Quickly and easily attaches to concrete, steel or composite metal decking
- Integrated pin installs easily using powder-actuated or single-shot gas-actuated tools
- Works with most standard nVent CADDY spring steel fasteners designed for rod attachments
- Rod is rigid and does not require secondary attachment to ceiling grid per NEC 300.11
- Stocked inventory - available when you need it
- Includes pre-assembled end-cap
- Specialized packaging simplifies material handling and minimizes sorting
- Rods are ready to install out of the box

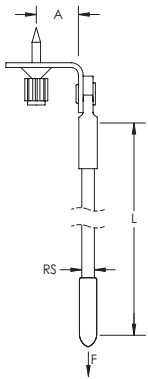

Material: Steel  
Finish: Electrogalvanized



Part Number	Length L	Rod Size RS	A	Static Load F
DR4TSF12	12"	1/4"	1.3"	95 lb
DR4TSF24	24"	1/4"	1.3"	95 lb
DR4TSF36	36"	1/4"	1.3"	95 lb
DR4TSF40	40"	1/4"	1.3"	95 lb
DR4TSF48	48"	1/4"	1.3"	95 lb
DR4TSF60	60"	1/4"	1.3"	95 lb
DR4TSF72	72"	1/4"	1.3"	95 lb

Uses Powers Fasteners, Inc. part number 50378.

Static load was established based on a 1-1/8" [28.6 mm] embedment depth and 3,000 psi [20.68 Mpa] normal-weight concrete. For variations in embedment and material please consult [www.powers.com](http://www.powers.com).

Pre-assembled drive pin from Powers Fasteners, Inc. works with Powers® C4CZ, Simpson® GCN-MEPKT, SPIT® P1000, P200, P2201, P3500 / PA3500, P35s, P45, P60, P7201, Sniper; Ramset® 721, Cobra, D45 / D60 / D60L, M70, SA270, T3SS, TS750P, TS60P, Viper; Hilti® DX35, DX350 / DX351 / DX36M, DX100 / DX200, DX460, DXA40, DXA41, DXE72 / DX400; Würth Diva-1, BST-1, BST-2 or equivalent nailers.

For shot-fired supports in seismic design category D, E, or F, maximum load is the lesser of 90 lb (400 N) or the published load.

Exempt from seismic design when supporting conduits less than 2-1/2" [64 mm] trade size, regardless of Ip.

# SCH1 Single Piece Strut Clamp for Conduit



- One-piece conduit clamp
- No screws or bolts to drop
- Requires only a screwdriver or nutdriver for installation
- Fits into open side of strut channel

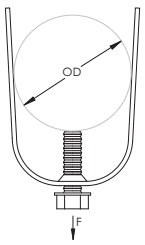

Material: Steel  
Finish: Electrogalvanized



Part Number	Outer Diameter OD	EMT Conduit Size	Rigid Conduit/Pipe Size	Static Load F
SCH8	0.34" – 0.71"	1/2"	-	200 lb
SCH12	0.57" – 0.92"	3/4"	1/2"	200 lb
SCH16	0.72" – 1.16"	1"	3/4"	200 lb
SCH20	1.00" – 1.51"	1 1/4"	1"	200 lb



# SCH2 Single Piece Strut Clamp for Cable/Conduit



- One-piece cable/conduit clamp with protective boot
- No screws or bolts to drop
- Requires only a screwdriver or nutdriver for installation
- Fits into open side of strut channel
- FM® Specification Tested (from 1/2" to 4" of EMT Conduit Size)

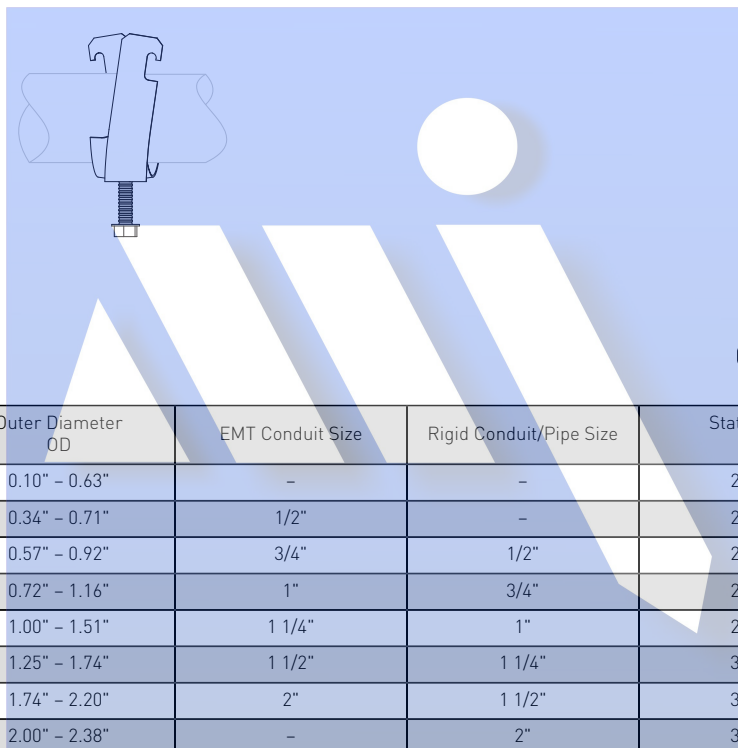
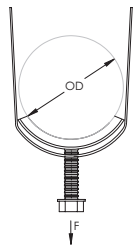

Material: Steel  
Finish: Electrogalvanized



Part Number	Outer Diameter OD	EMT Conduit Size	Rigid Conduit/Pipe Size	Static Load F	Certifications
SCH6B	0.10" – 0.63"	-	-	200 lb	cULus, E30, E60, E90
SCH8B	0.34" – 0.71"	1/2"	-	200 lb	cULus, E30, E60, E90
SCH12B	0.57" – 0.92"	3/4"	1/2"	200 lb	cULus, E30, E60, E90
SCH16B	0.72" – 1.16"	1"	3/4"	200 lb	cULus, E30, E60, E90
SCH20B	1.00" – 1.51"	1 1/4"	1"	200 lb	cULus, E30, E60, E90
SCH24B	1.25" – 1.74"	1 1/2"	1 1/4"	350 lb	cULus
SCH32B	1.74" – 2.20"	2"	1 1/2"	350 lb	cULus
SCH40B	2.00" – 2.38"	-	2"	350 lb	cULus
SCH48B	2.38" – 2.88"	2 1/2"	2 1/2"	350 lb	cULus
SCH56B	2.72" – 3.50"	3"	3"	350 lb	cULus
SCH64B	3.25" – 4.00"	3 1/2"	3 1/2"	350 lb	cULus
SCH72B	3.85" – 4.50"	4"	4"	350 lb	cULus

# SK Single Piece Strut Clamp for Conduit



- One piece break apart strut clamp for EMT and Rigid conduit
- Includes thread impression and captured screw

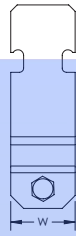
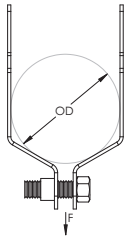

Part Number	EMT Conduit Size	Rigid Conduit/ Pipe Size	Outer Diameter OD	Width W	Static Load F	Certifications
Material: Aluminum						
SK8ALA	1/2"	1/2"	0.71" – 0.84"	1 1/4"	150 lb	-
SK12ALA	3/4"	3/4"	0.92" – 1.05"	1 1/4"	150 lb	-
SK16ALA	1"	1"	1.16" – 1.32"	1 1/4"	150 lb	-
SK20ALA	1 1/4"	1 1/4"	1.51" – 1.66"	1 1/4"	150 lb	-
SK24ALA	1 1/2"	1 1/2"	1.74" – 1.90"	1 1/4"	150 lb	-
SK32ALA	2"	2"	2.20" – 2.38"	1 1/4"	150 lb	-
Material: Steel – Finish: Electrogalvanized						
SK85I	1/2"	1/2"	0.71" – 0.84"	1 1/4"	200 lb	cULus
SK125I	3/4"	3/4"	0.92" – 1.05"	1 1/4"	200 lb	cULus
SK165I	1"	1"	1.16" – 1.32"	1 1/4"	200 lb	cULus
SK205I	1 1/4"	1 1/4"	1.51" – 1.66"	1 1/4"	200 lb	cULus
SK245I	1 1/2"	1 1/2"	1.74" – 1.90"	1 1/4"	200 lb	cULus
SK325I	2"	2"	2.20" – 2.38"	1 1/4"	200 lb	cULus
SK405I	2 1/2"	2 1/2"	2.88"	1 1/4"	350 lb	cULus
SK485I	3"	3"	3.50"	1 1/4"	350 lb	cULus
SK565I	3 1/2"	3 1/2"	4.00"	1 1/4"	350 lb	cULus
SK645I	4"	4"	4.50"	1 1/4"	350 lb	cULus

# Strut Channel Type A, Slotted

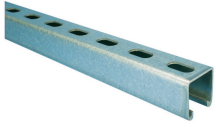

- Cold formed channel, slotted
- Strut channels for heavy applications
- For individual fastening or for efficiently constructing pipe or tube routes

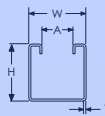
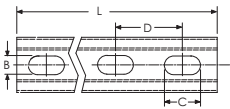

Part Number	Length L	Height H	Width W	Thickness T	A	B	C	D
Material: Steel – Finish: Hot-Dip Galvanized								
A12H1000HD	10'	1 5/8"	1 5/8"	12 GA	7/8"	9/16"	1 1/8"	2"
A12H2000HD	20'	1 5/8"	1 5/8"	12 GA	7/8"	9/16"	1 1/8"	2"
Material: Steel – Finish: Painted – Color: Green								
A12H1000GN	10'	1 5/8"	1 5/8"	12 GA	7/8"	9/16"	1 1/8"	2"
A14H1000GN	10'	1 5/8"	1 5/8"	14 GA	7/8"	9/16"	1 1/8"	2"
A12H2000GN	20'	1 5/8"	1 5/8"	12 GA	7/8"	9/16"	1 1/8"	2"
A14H2000GN	20'	1 5/8"	1 5/8"	14 GA	7/8"	9/16"	1 1/8"	2"
Material: Steel – Finish: Pregalvanized								
A12H1000PG	10'	1 5/8"	1 5/8"	12 GA	7/8"	9/16"	1 1/8"	2"
A14H1000PG	10'	1 5/8"	1 5/8"	14 GA	7/8"	9/16"	1 1/8"	2"
A12H2000PG	20'	1 5/8"	1 5/8"	12 GA	7/8"	9/16"	1 1/8"	2"
A14H2000PG	20'	1 5/8"	1 5/8"	14 GA	7/8"	9/16"	1 1/8"	2"
Material: Stainless Steel 304 [EN 1.4301]								
A12H1000S4	10'	1 5/8"	1 5/8"	12 GA	7/8"	9/16"	1 1/8"	2"

# Strut Channel Type C, Slotted

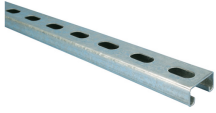

- Cold formed channel, slotted
- Strut channels for medium to heavy applications
- For individual fastening or for efficiently constructing pipe or tube routes

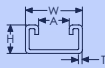
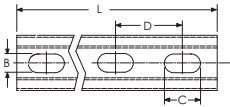

Part Number	Length L	Height H	Width W	Thickness T	A	B	C	D
Material: Steel - Finish: Painted - Color: Green								
C12H1000GN	10'	13/16"	1 5/8"	12 GA	7/8"	9/16"	1 1/8"	2"
C14H1000GN	10'	13/16"	1 5/8"	14 GA	7/8"	9/16"	1 1/8"	2"
C12H2000GN	20'	13/16"	1 5/8"	12 GA	7/8"	9/16"	1 1/8"	2"
C14H2000GN	20'	13/16"	1 5/8"	14 GA	7/8"	9/16"	1 1/8"	2"
Material: Steel - Finish: Pregalvanized								
C12H1000PG	10'	13/16"	1 5/8"	12 GA	7/8"	9/16"	1 1/8"	2"
C14H1000PG	10'	13/16"	1 5/8"	14 GA	7/8"	9/16"	1 1/8"	2"
C12H2000PG	20'	13/16"	1 5/8"	12 GA	7/8"	9/16"	1 1/8"	2"
C14H2000PG	20'	13/16"	1 5/8"	14 GA	7/8"	9/16"	1 1/8"	2"
Material: Stainless Steel 304 [EN 1.4301]								
C14H1000S4	10'	13/16"	1 5/8"	14 GA	7/8"	9/16"	1 1/8"	2"

# INC8 Internal Strut Beam Clamp



- Mounts strut within beams

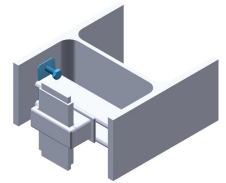
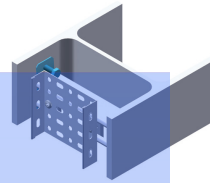
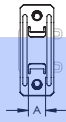
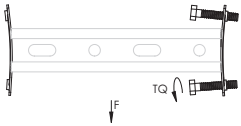

Material: Spring Steel  
 Finish: nVent CADDY Armour

Part Number	Strut Type	A	Screw Diameter Sc	Screw Length L	Torque TQ	Static Load F	Standard Packaging Quantity
INC8T5	A (1 5/8" x 1 5/8"), C (13/16" x 1 5/8")	0.51"	5/16"	1"	5 ft lb	100 lb	100 pc

# Telescoping Screw Gun Box Bracket

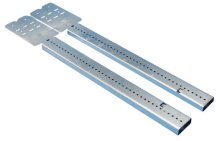

- Can mount multiple boxes
- Notched and marked for easy identification and bending
- Improved design with stamped inch markings and pilot holes accelerates precise box conduit mounting between studs
- Pilot holes allow easy box attachment with a screwdriver
- Requires only a screw gun to install
- Can be mounted to face or inside of stud
- Adjustable for non-standard stud spacing
- Interlocking tab prevents accidental disassembly
- Unique, one-piece, break apart design
- Reduces movement of the box when used with flexible conduit, ENT, MC, AC or non-metallic sheathed cable

Material: Steel  
Finish: Pregalvanized



Part Number	Stud Spacing	Box Depth	Standard Packaging Quantity
TSGB16	11" - 18"	1 1/2", 2 1/8"	50 pc
TSGB1624	15 3/4" - 25"	1 1/2", 2 1/8", 2 1/2"	50 pc
TSGB24	17" - 26"	1 1/2", 2 1/8", 2 1/2"	50 pc

# Plastic Low Voltage Mounting Plate



- No sharp metal edges with plastic design
- Fast, easy way to install
- No installation tools required to secure bracket in the drywall opening
- Serrated interlocking system secures tightly
- Template points on brackets help eliminate multiple measurement markings during installation
- Recessed design helps assure flush mount of device
- Eliminates the need for electrical boxes on low voltage class 2 applications

Material: Acrylonitrile Butadiene Styrene  
 Finish: Plain



Part Number	Gang	Drywall Thickness
MP1P	1	1/4" - 1 1/4"
MPAL2	2	1/4" - 1 1/4"
MP34P	3, 4	1/4" - 1 1/4"

No load rating, for positioning only.  
 For low voltage Class 2 use only.



# Heavy Duty T-Grid Box Hanger

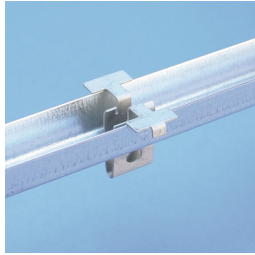
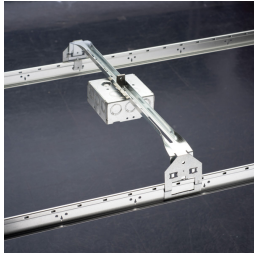

- Quickly mounts a box to T-grid
- Adjustable height for various electrical box depths
- Mounts flush with face of tile
- Installs by hand
- Drop wire for independent support from clip and/or bar
- Screws easily to tee bar for added stability
- Supports multiple box installations

Material: Steel, Spring Steel  
 Finish: Pregalvanized, nVent CADDY Armour



Part Number	Included Components	Length	Box Depth	Ultimate Static Load	Certifications	Standard Packaging Quantity
512HD	Mounting Clip	24"	1 1/2", 2 1/8"	50 lb	cULus	25 pc
512HDEEP	Mounting Clip, Extension Bracket	24"	1 1/2", 2 1/8"	50 lb	-	25 pc

Standard bar mounts 2 1/8" box. Break off tabs for 1 1/2" deep box. Mounts flush with face of tile.  
 512HDEEP Series with additional 512HDXT mounts 2 1/8" deep box with 1 1/2" extension ring.  
 Not permitted for paddle fans.

FM is a registered certification mark of FM Approvals LLC, LTD. HILTI is a registered trademark of Hilti Aktiengesellschaft. NEC is a registered trademark of, and National Electrical Code (NEC) standard is a copyright of the National Fire Protection Association, Inc. Ramset is a registered trademark of Illinois Tool Works, Inc. Simpson is a registered trademark of Simpson Strong-Tie Company Inc. SPIT is a registered trademark of Societe De Prospection & D'Inventions Techniques Spit. UL, UR, cUL, cUR, cULus and cURus are registered certification marks of UL LLC.

**WARNING**  
 nVent products shall be installed and used only as indicated in nVent's product instruction sheets and training materials. Instruction sheets are available at [www.erico.com](http://www.erico.com) and from your nVent customer service representative. Improper installation, misuse, misapplication or other failure to completely follow nVent's instructions and warnings may cause product malfunction, property damage, serious bodily injury and death and/or void your warranty.

© 2019 nVent All rights reserved  
 nVent, nVent CADDY, nVent ERICO, nVent ERIFLEX and nVent LENTON are owned by nVent or its global affiliates.  
 All other trademarks are the property of their respective owners. nVent reserves the right to change specifications without prior notice.

